

Продуктова брошура 2017



MIG23
turnkey engineering

Ул. Костенец 12

София, 1612

e-mail:office@mig23-bg.com

web:www.mig23-bg.com

phone:+359 2 9526 925

Кои сме ние?

Ние сме проектантска и инженерингова компания, базирана в София, България, основана през 2005 г. от опитни професионалисти. Повече от десет години активно развиваме разнообразна гама от дейности, от малки системи за захранване до комплексни индустриални проекти.

Специализирани сме в предлагането на цялостни инженерни решения в енергетиката, като работа ни се фокусира върху предизвикателните идеи на нашите клиенти.

Ние се практикуваме изследователски подход, който се основава на най-новите технологии в сферата, като прилагаме иновативни и находчиви инженерни решения за постигането на надеждни резултати.

Ние сме лидер в производството на комплектни трансформаторни постове, системи за компенсирание на реактивна енергия и табла в България.

Компенсираща уредба до 250 кVAr

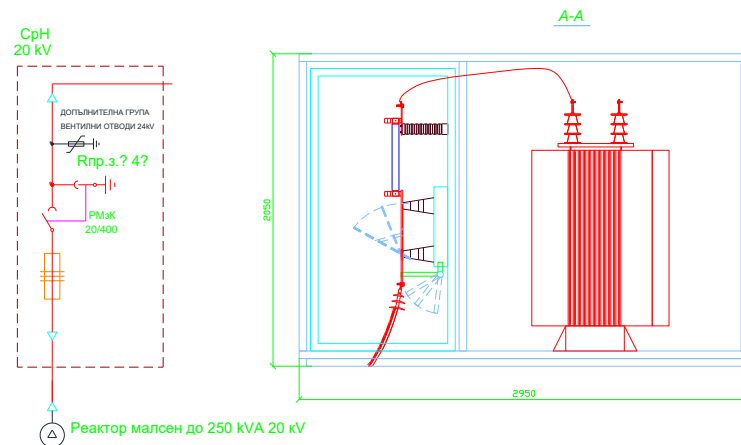
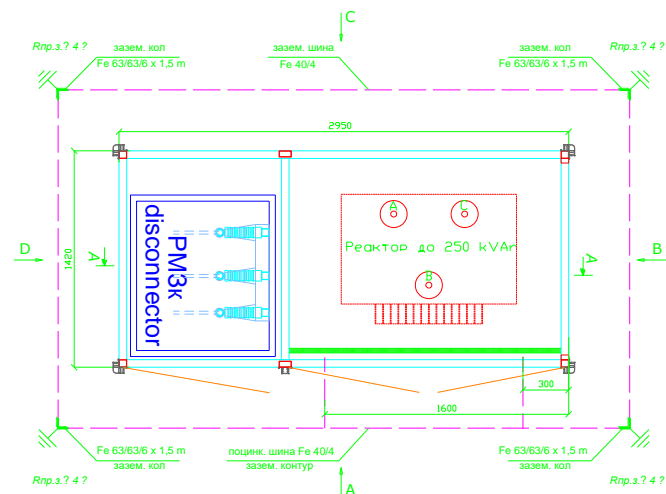

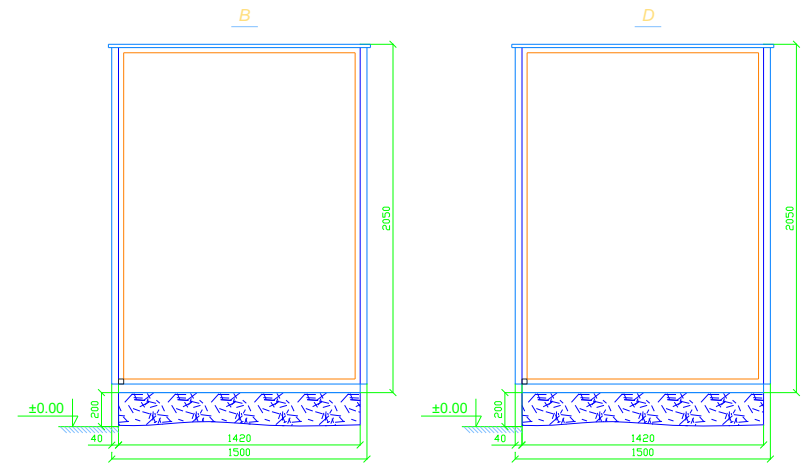
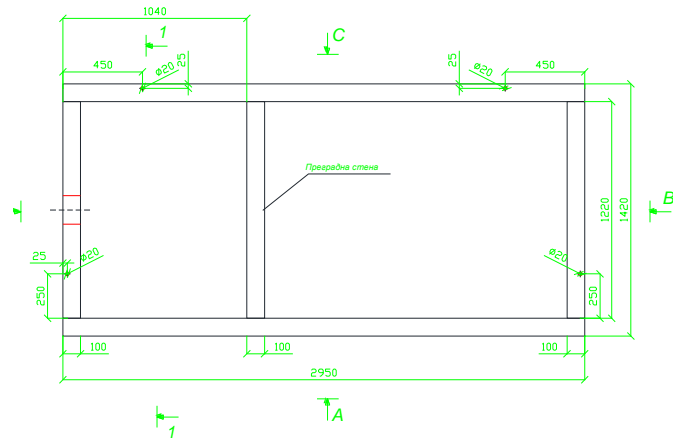
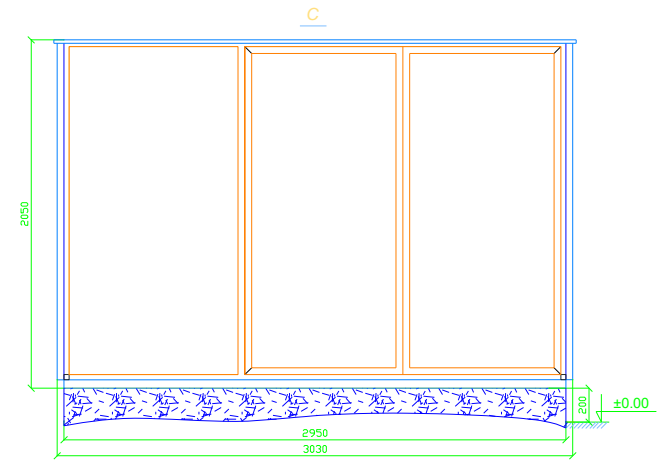
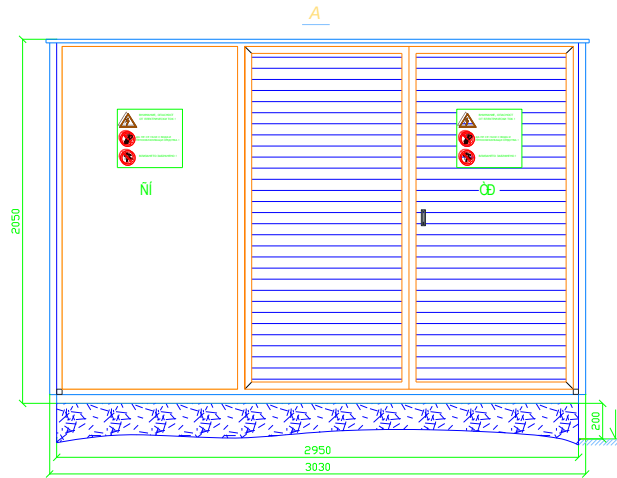

Измерване на електрическа енергия на стълб

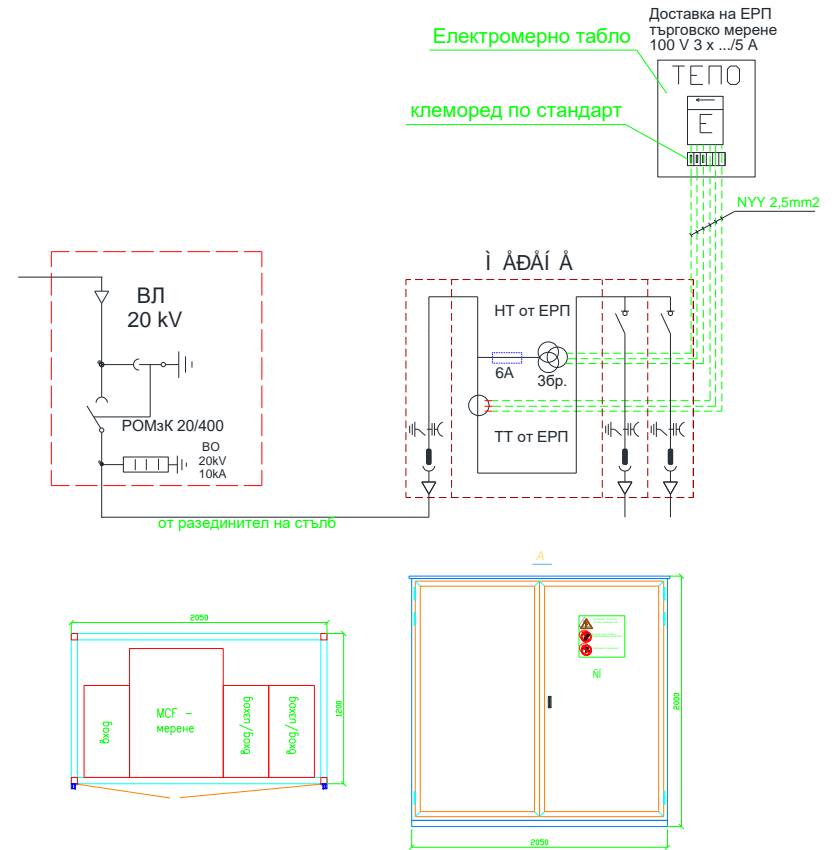

МКРУ 20kV

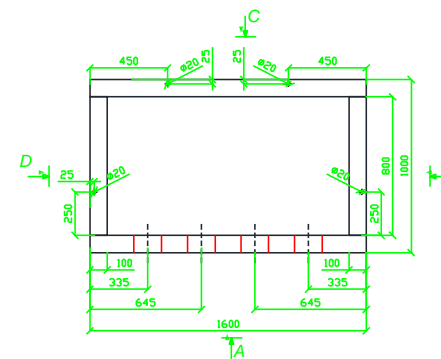
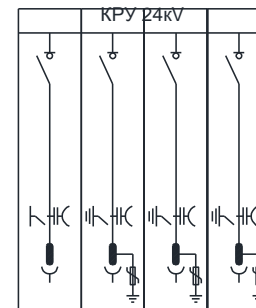
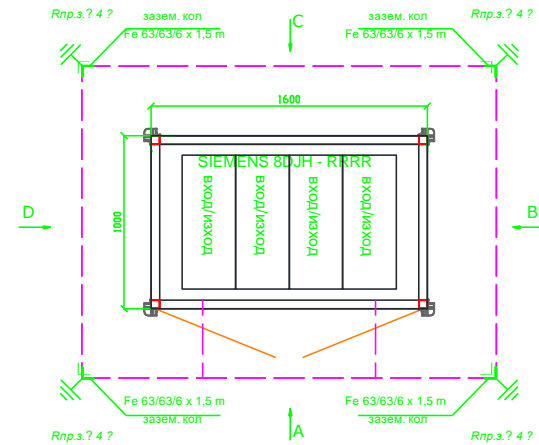

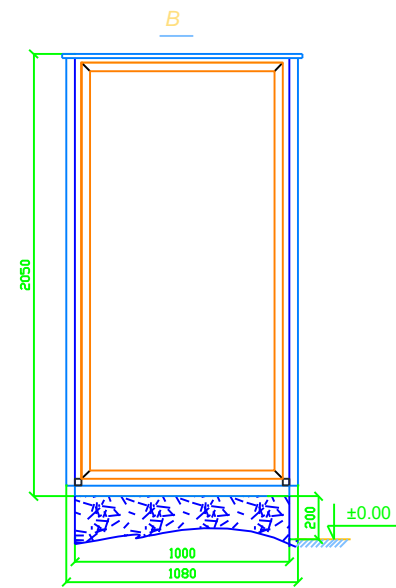
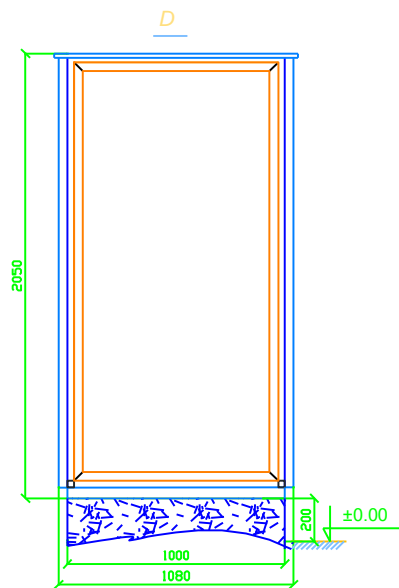
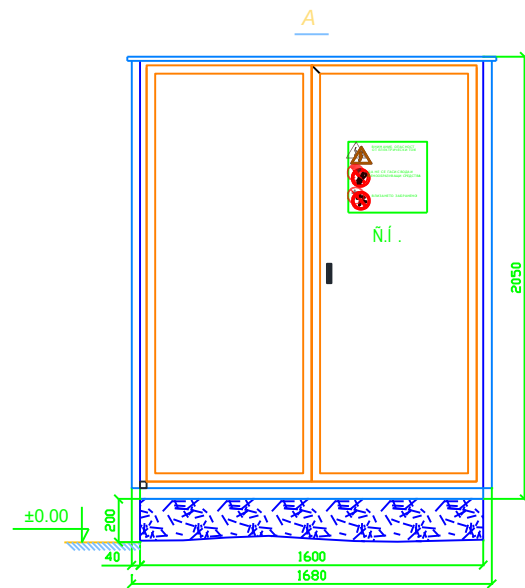
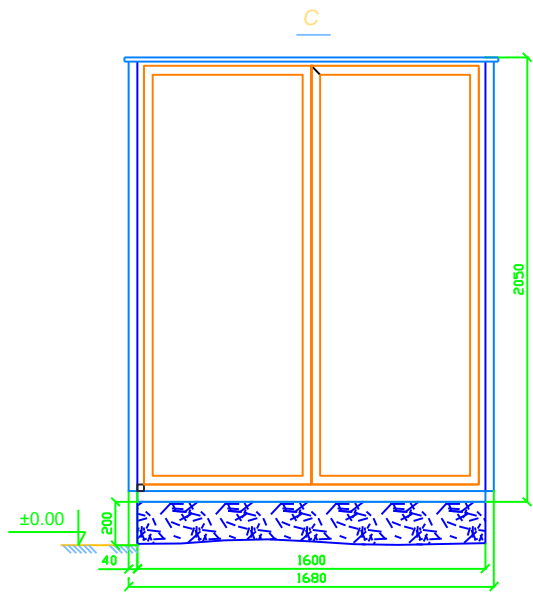

МКТП

До 100kVA

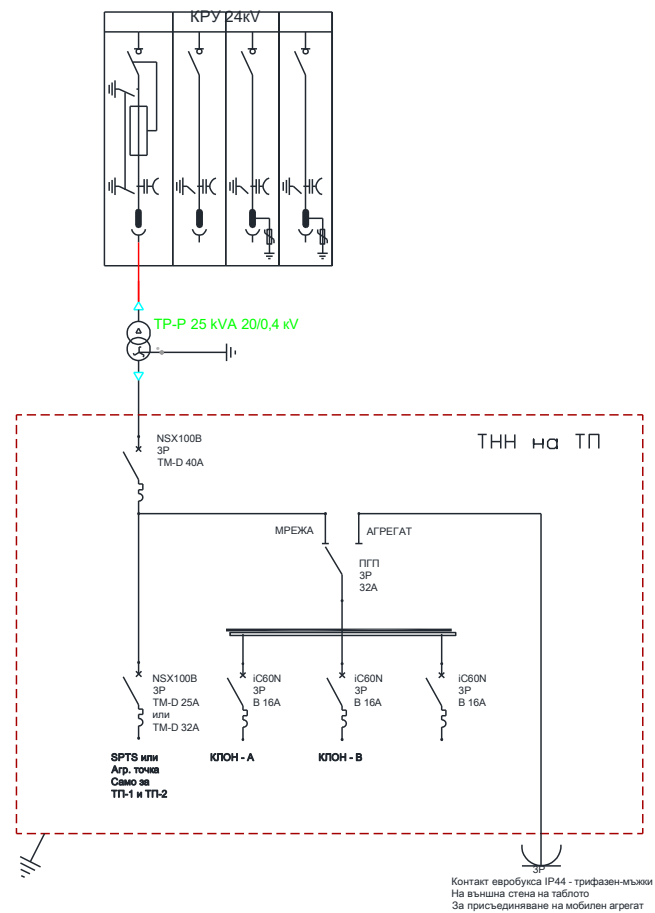

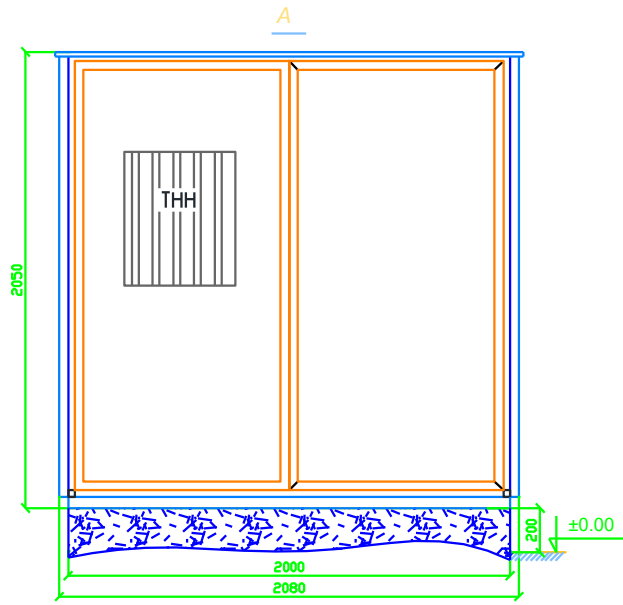
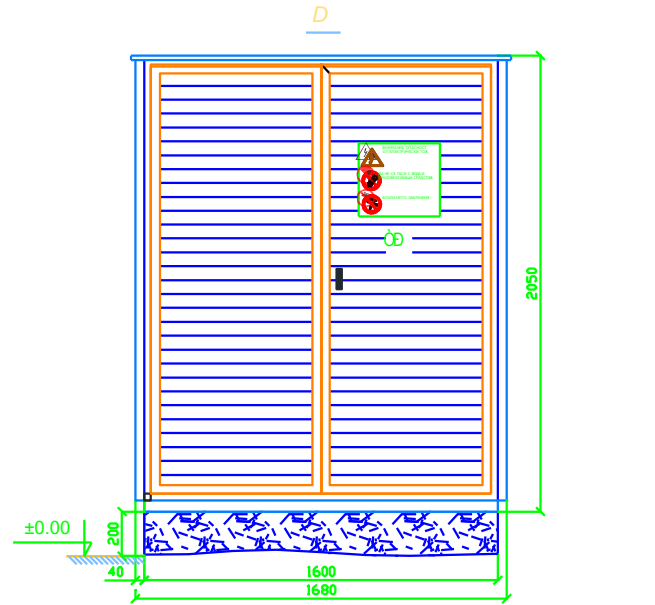
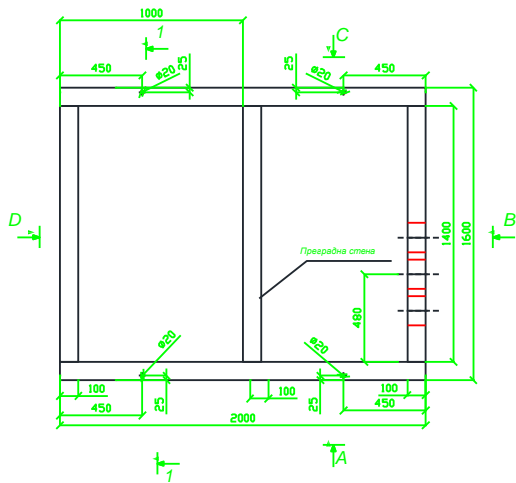
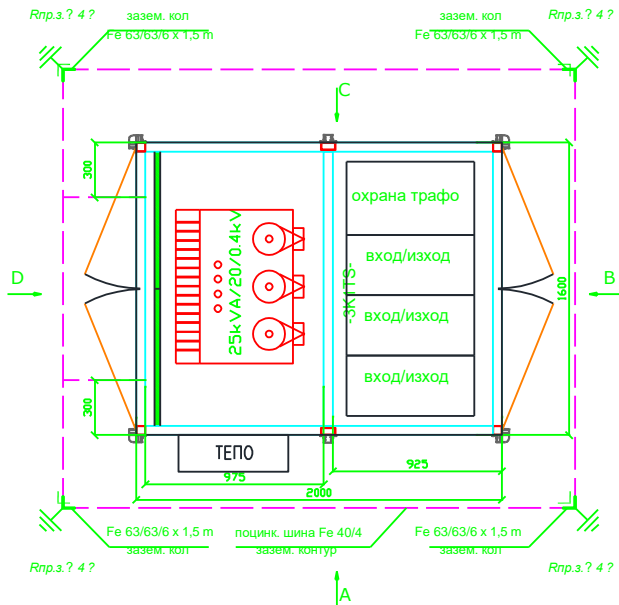

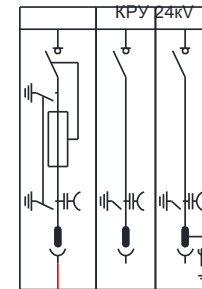
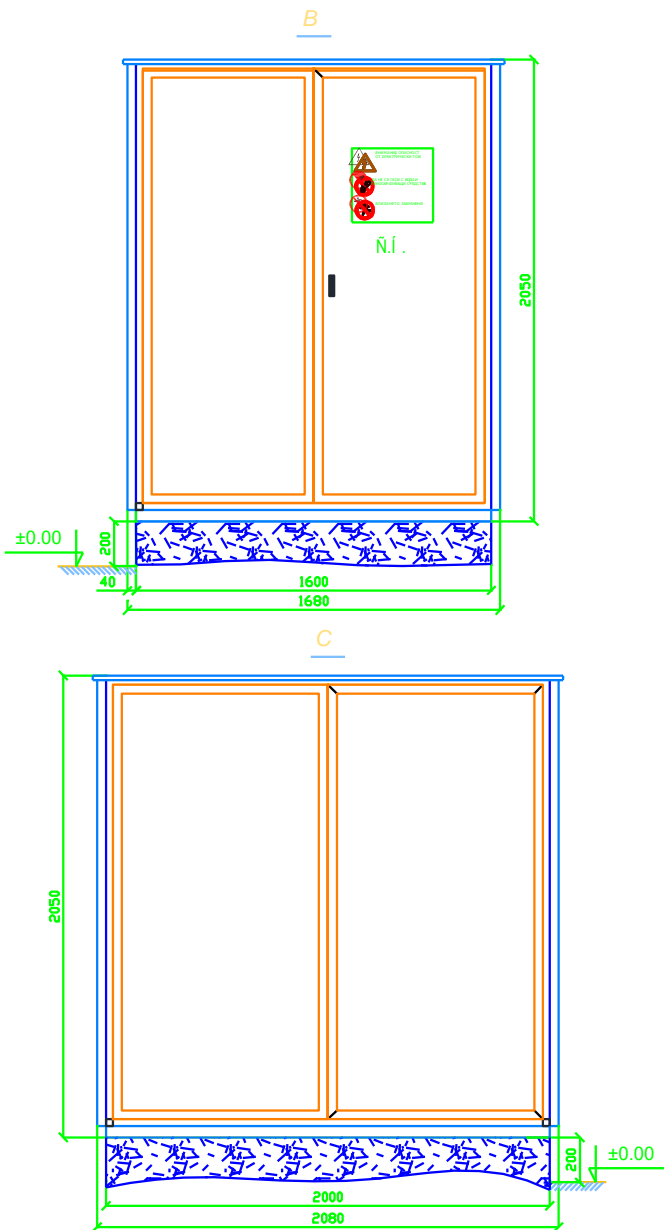

TP-P 25 kVA 20/0,4 kV

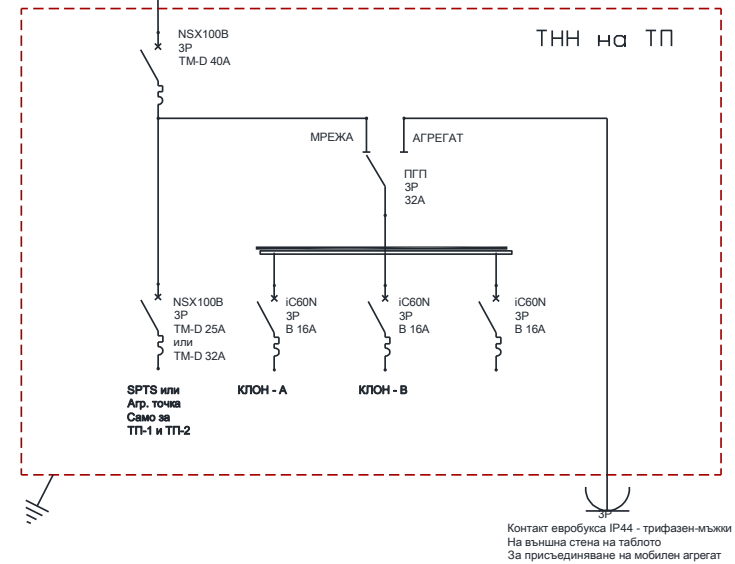

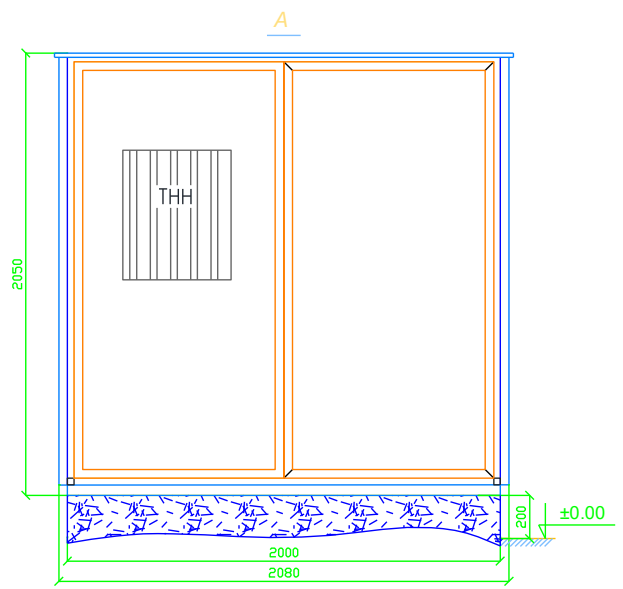
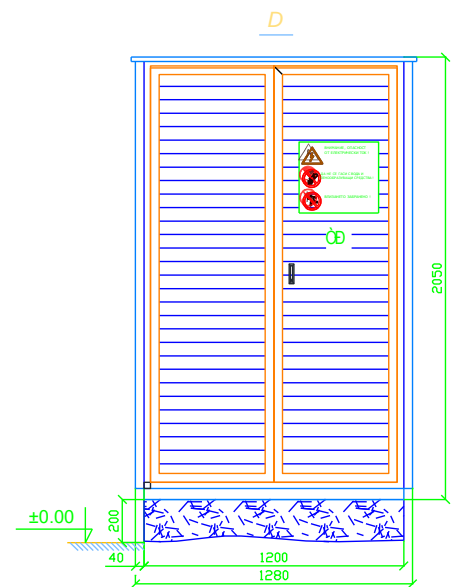
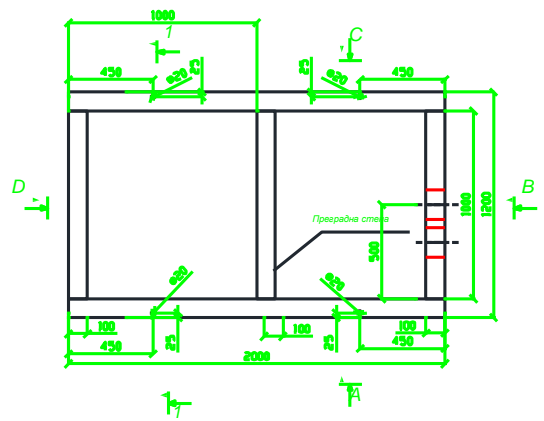
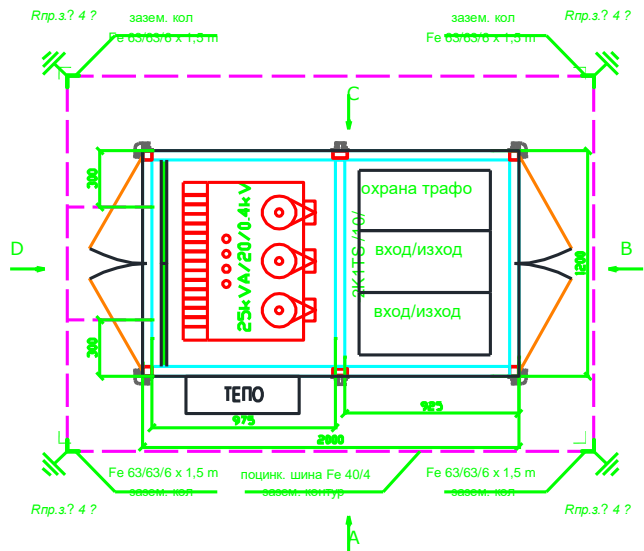

МТТ

До 100kVA

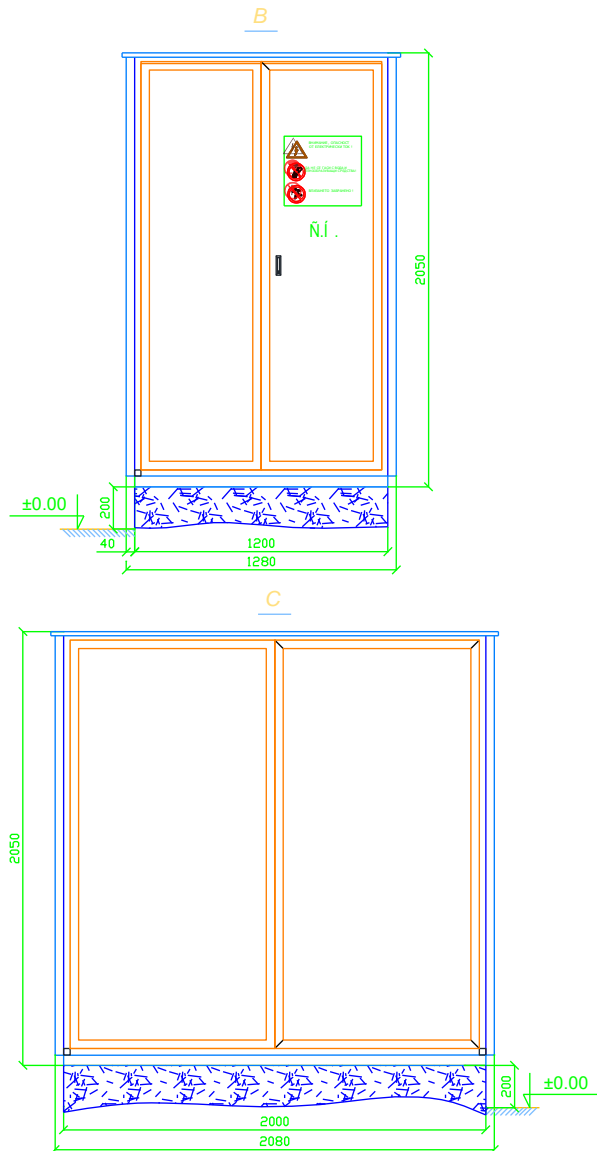

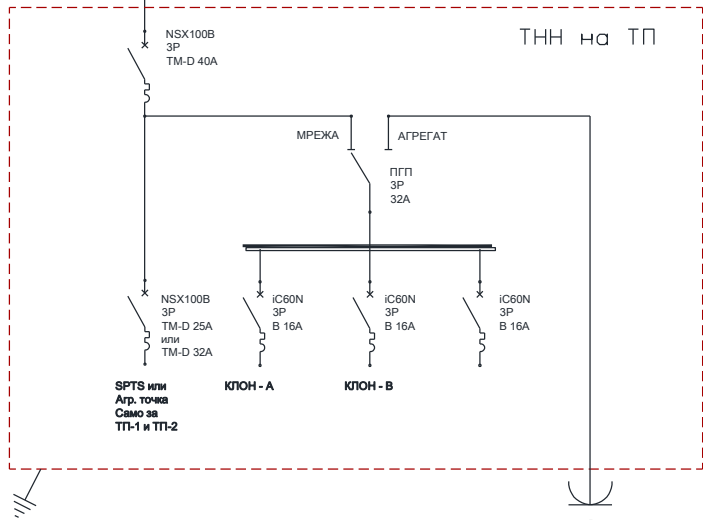
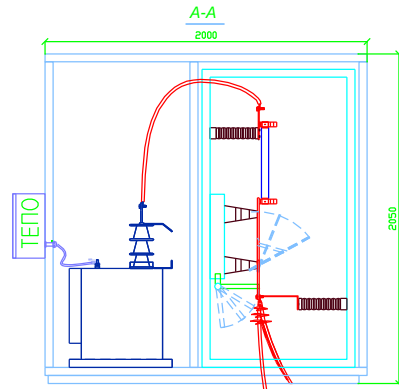
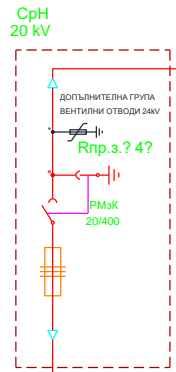

Контакт евробуса IP44 - трифазен-мъжки
На външна стена на таблото
За присъединяване на мобилен агрегат

